

HOOD SCHEDULE

HOOD							EXHAUST COLLAR				COLLAR AREA	GREASE DUCT VELOCITY	FILTERS			FILTER AREA	VELOCITY THRU EX FILTERS	LIGHTS	
#	MFG.	MODEL	LENGTH	TYPE	MATERIAL	WGT (LBS)	QTY	SIZE	S.P.	CFM	(SQFT)	(FPM)	TYPE	QTY	SIZE	(SQFT)	(FPM)	QTY	TYPE
1	RKV	KHE-964824	8'-0"	TYPE I	430 S/S EXPOSED	360	1	10 x 20	0.516"	2080	1.39	1613	TYPE VI	1	20 x 16	12.25	183	2	INCANDESCENT / CFL
														4	20 x 20				

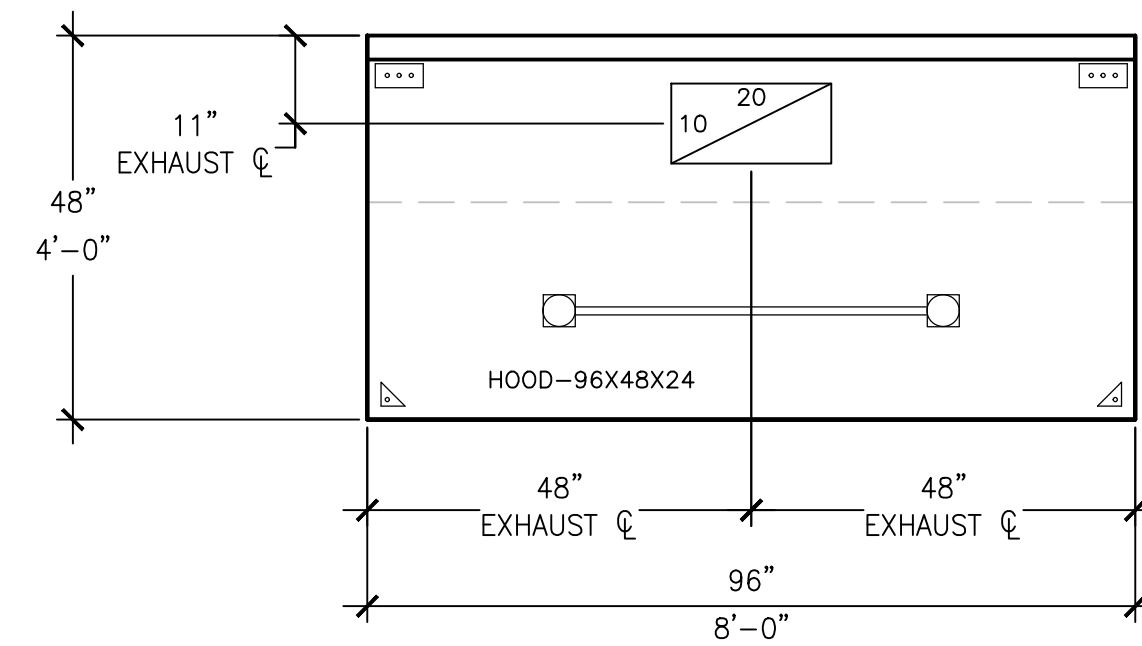

PLAN VIEW

1/2" = 1'-0"

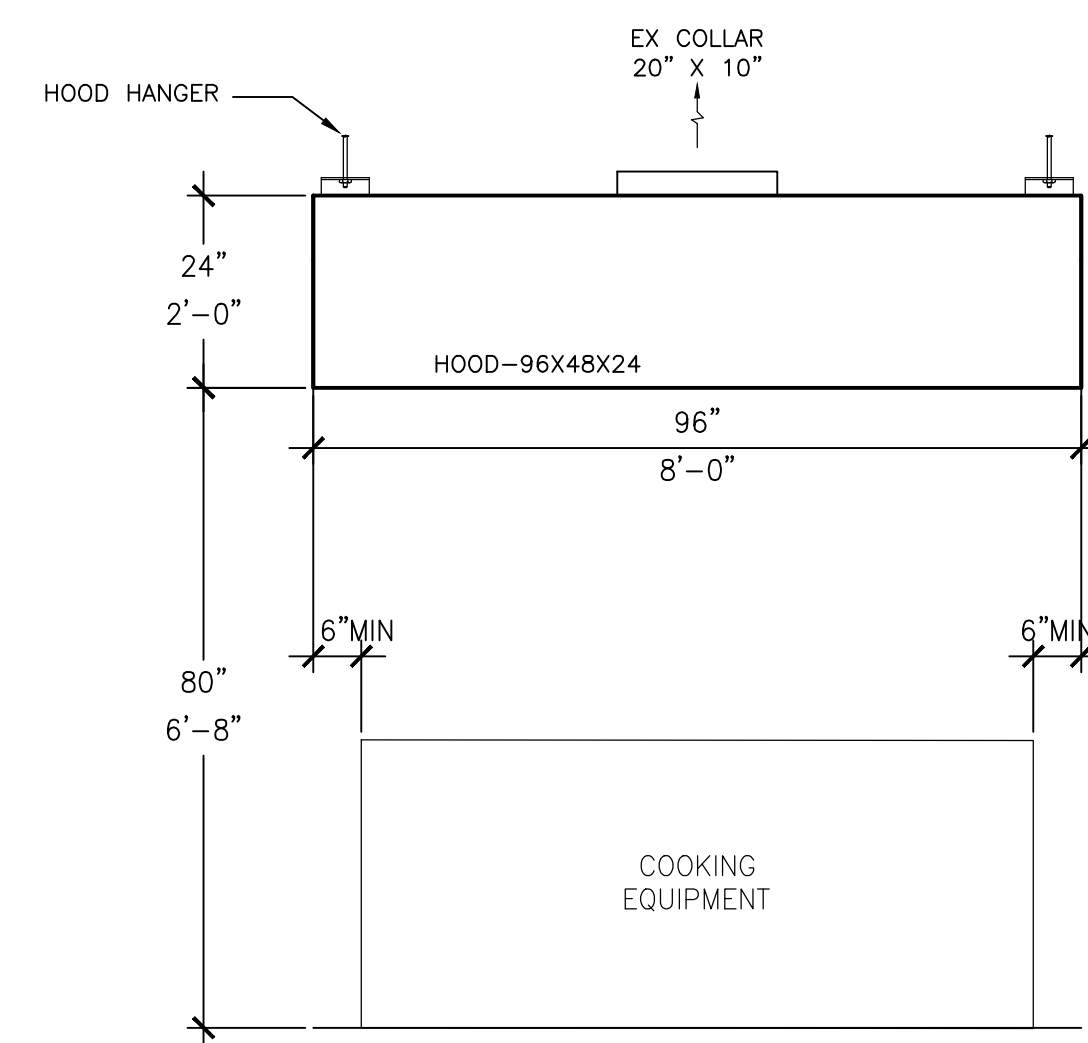

FRONT VIEW

1/2" = 1'-0"

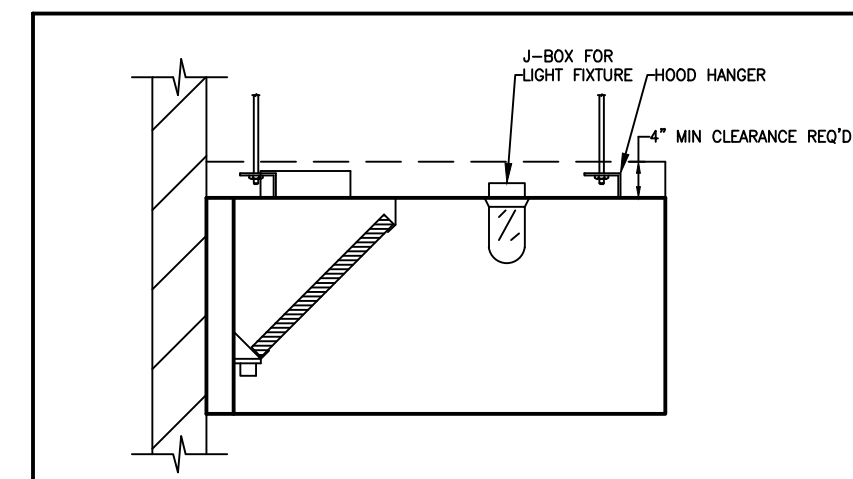

TOP OF HOOD CLEARANCE

SCALE: N.T.S.

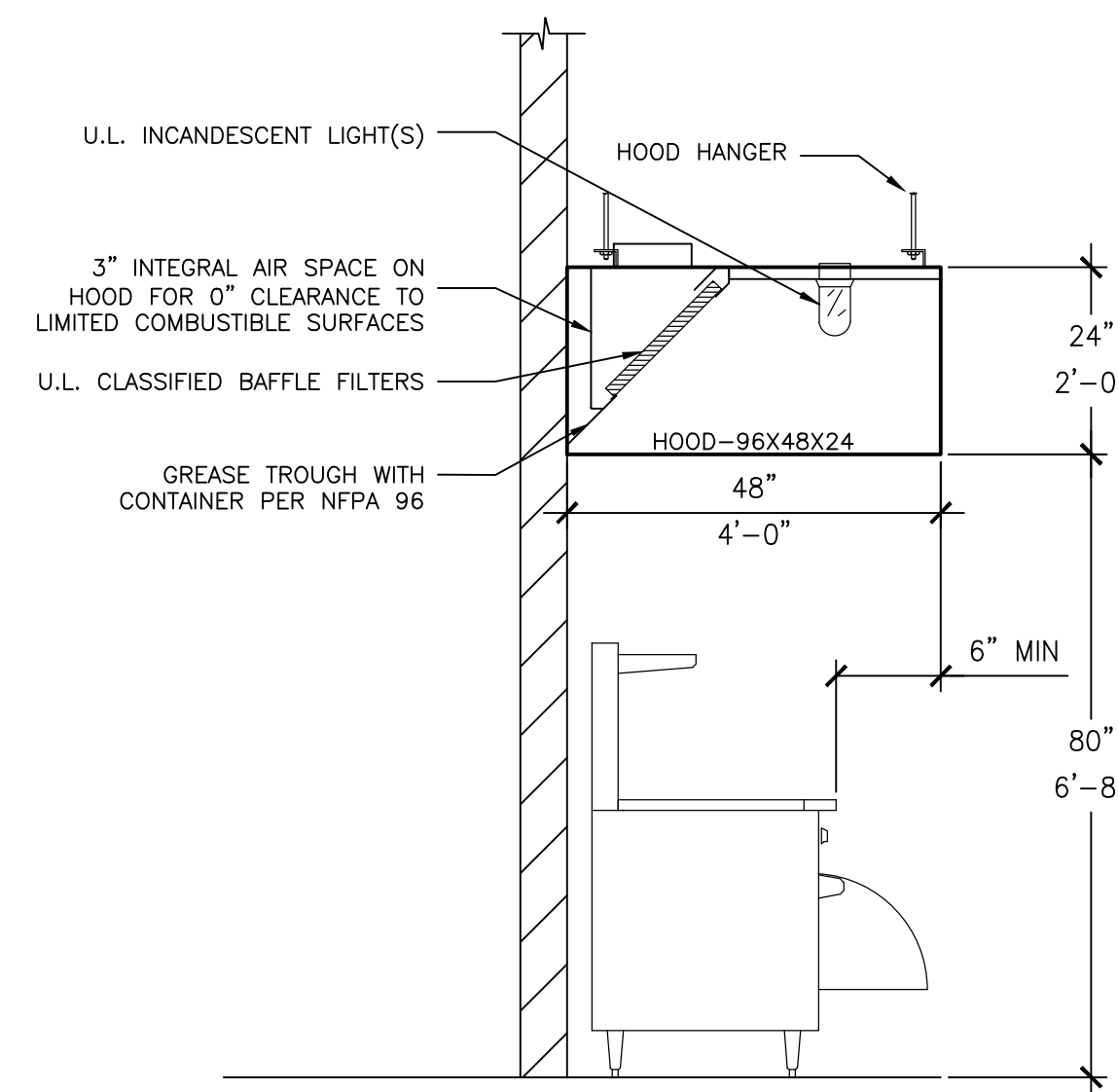

LEFT SIDE ELEVATION

SCALE: 1/2" = 1'-0"

GENERAL NOTES:

UL RANGE HOOD:

MATERIAL 18GA STAINLESS STEEL CONSTRUCTION ON EXPOSED SURFACES. 18 GA. GALV ON EXH PLENUM; ALL CONTINUOUS LIQUID TIGHT WELDS GROUND AND POLISHED. FILTERS ARE UL CLASSIFIED BAFFLE TYPE SET IN HOOD AT 45 DEG ANGLE. INCANDESCENT LIGHT FIXTURE(S) UL LISTED FOR USE IN COMMERCIAL COOKING HOODS. INTEGRAL PITCHED NON EXPOSED GREASE TRAY BELOW FILTERS WITH REMOVABLE GREASE CONTAINER WITH A LIQUID VOLUME LESS THAN 1 QT, ALL IN COMPLIANCE WITH NFPA #96 AND INTERNATIONAL BUILDING CODE.

LOWER CFM MODELS AVAILABLE FOR LIGHT AND MEDIUM DUTY COOK LINES. PLEASE CONSULT FACTORY FOR DETAILS.

MODEL "KHE" EXHAUST HOODS ARE U.L. LISTED FOR USE OVER COMMERCIAL COOKING APPLIANCES BY UNDERWRITER'S LABORATORIES IN ACCORDANCE WITH NFPA 96 AND UL 710 STANDARDS.
U.L. FILE #: MH18803



Dwg No.
KHE964824

Part No.
KHE964824

Quality Commercial Kitchen Ventilation Products

- S/S Wall Paneling
- Electric Hood Control Panels
- UL listed Exhaust Blowers
- UL listed Kitchen Hoods
- UL listed Grease Exhaust fans
- UL listed Supply Air Fans
- UL listed Gas Heated Supply Fans

E-MAIL:
sales@ReliableKitchenVentilation.com
www.ReliableKitchenVentilation.com



PN: KHE964824